

TEKNO CARRIERS

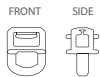

CLIC GLIDE
3/16" pin height



WAVE CARRIER
1/4" pin height



TEKNO CARRIER
1/4" pin height

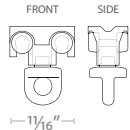

NEXGEN GLIDE
3/4" pin height



BALL BEARING CARRIER
5/8" pin height

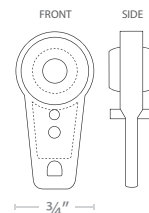

i Pin height measurements are to top of rail.
Add 1 1/8" to cover Nexgen rail.
Add 7/8" to cover Euro-scope.

EURO-SCOPE

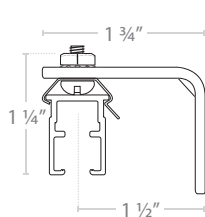

SHORT SUPPORT

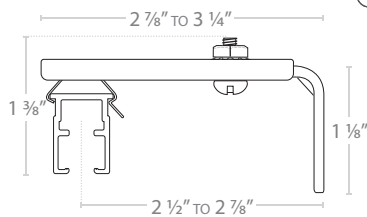

ADJUSTABLE SUPPORT

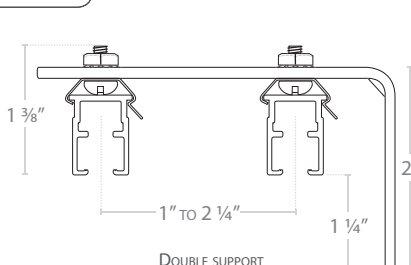

DOUBLE SUPPORT

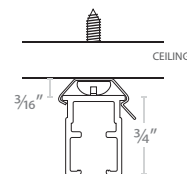

CEILING SUPPORT

TEKNO 25

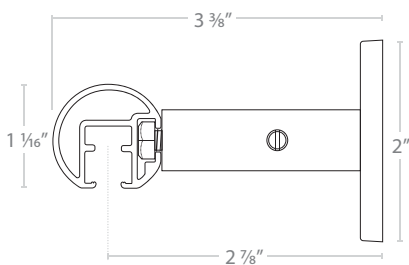

WALL SUPPORT

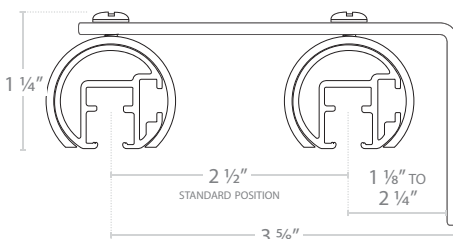

DOUBLE SUPPORT

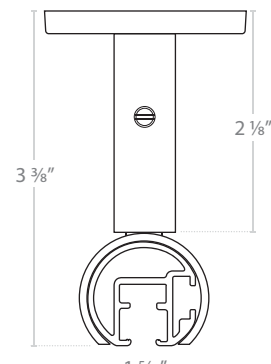

CEILING SUPPORT

KONTUR ALU & EVO

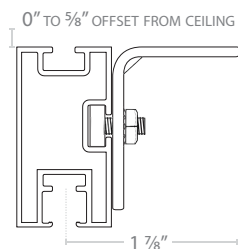

ALU CEILING SUPPORT

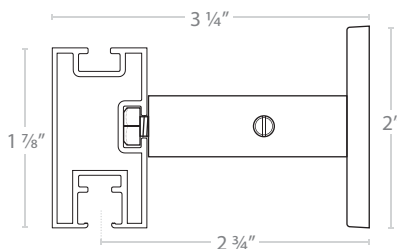

ALU WALL SUPPORT

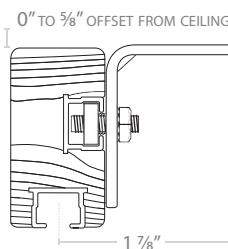

EVO CEILING SUPPORT

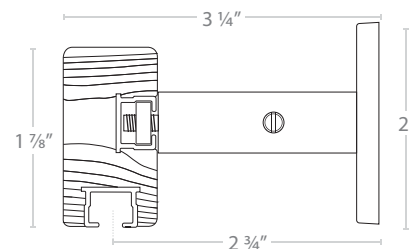

EVO WALL SUPPORT

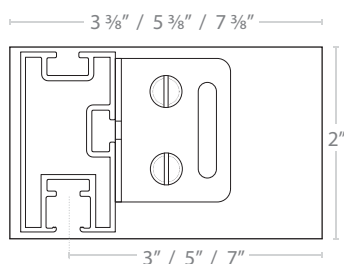

ALU QUADRA RETURN 2 / 4 / 6

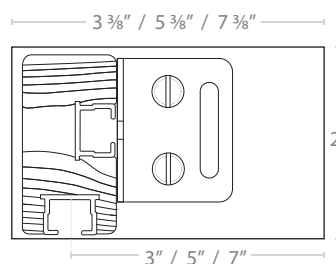

EVO QUADRA RETURN 2 / 4 / 6



URBAN 3 & 5

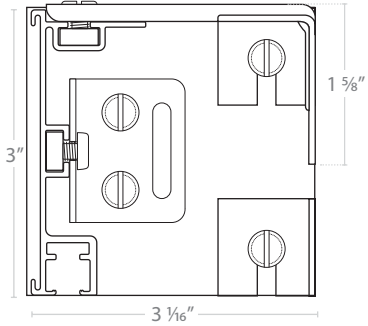

URBAN 3 RETURN 3
Showing all hardware

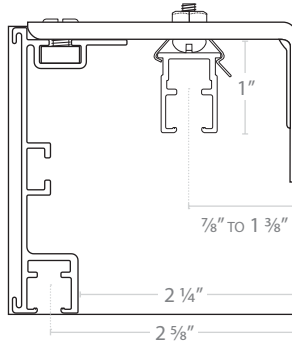

URBAN 3 RETURN 3
With Euro-Scope upgrade

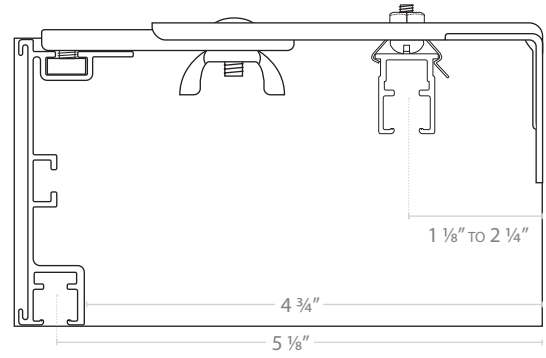

URBAN 3 - RETURN 5.5
With Euro-Scope upgrade

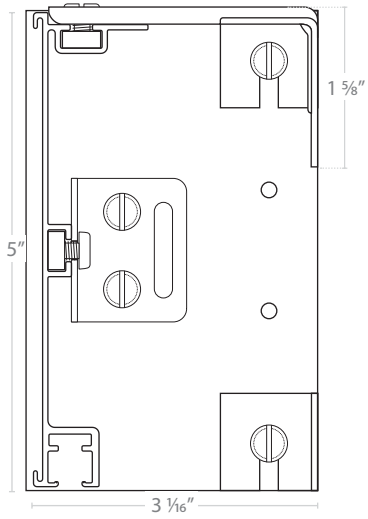

URBAN 5 RETURN 3
Showing all hardware

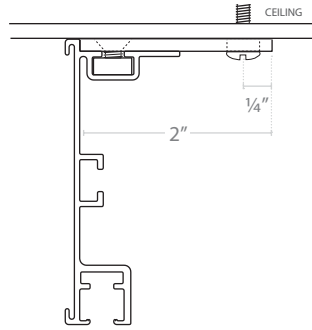

URBAN 3 CEILING SUPPORT

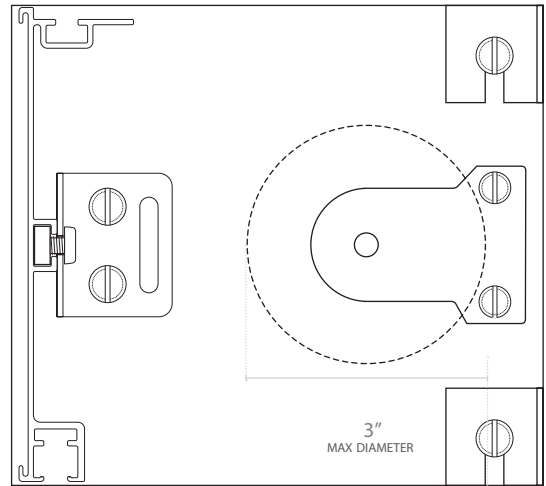

URBAN 5 - RETURN 5.5
Shade installation

INVISIBLE

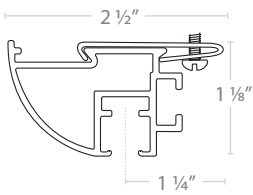

INVISIBLE CEILING CLIP

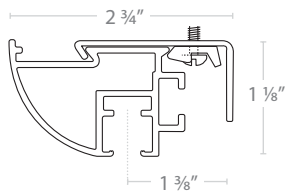

INVISIBLE SHORT PROJECTION SUPPORT

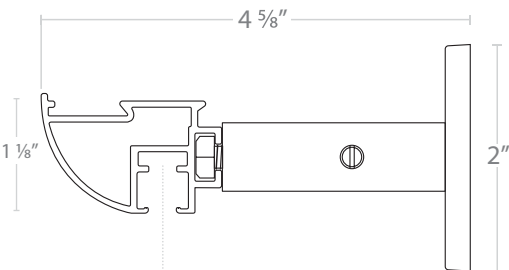

INVISIBLE TEKNO 2" PROJECTION
for Tekno 4" - add 2" for measurements from wall

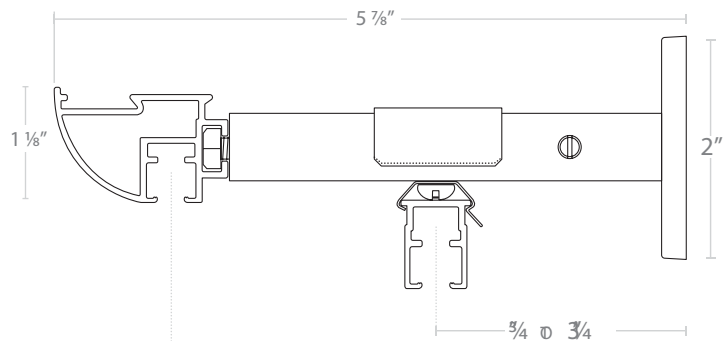

INVISIBLE TEKNO 4" PROJECTION WITH EURO SCOPE UPGRADE
for Tekno 6" projection - add 2" for measurements from wall

TECHNICAL INFORMATION • TEKNO PRODUCTS

NEXGEN

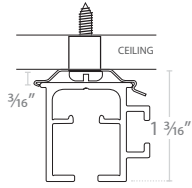

CEILING SUPPORT

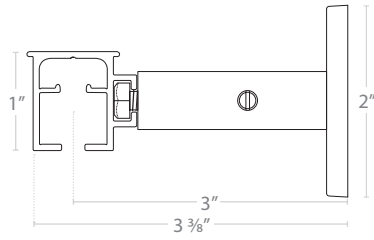

WALL SUPPORT

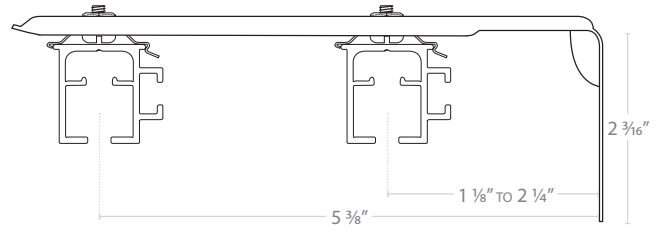

DOUBLE SUPPORT

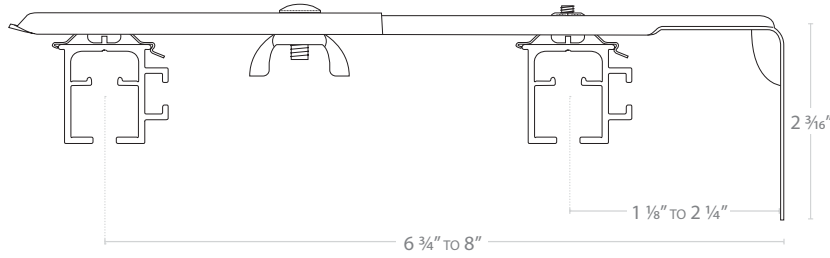

ADJUSTABLE DOUBLE SUPPORT

TEKNO 40

0" to 1/2" OFFSET FROM CEILING

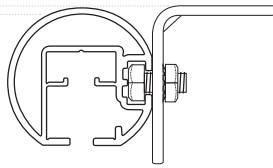

CEILING SUPPORT

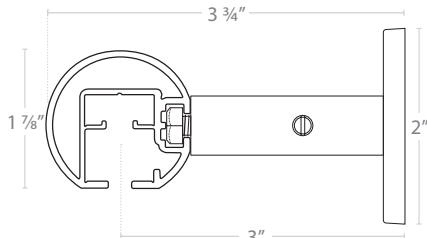

WALL SUPPORT

TEKNO 40 WOOD

0" to 1/2" OFFSET FROM CEILING

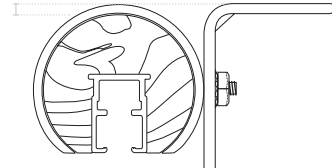

CEILING SUPPORT

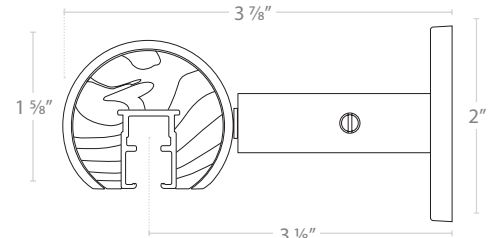

WALL SUPPORT

NEXGEN WOOD

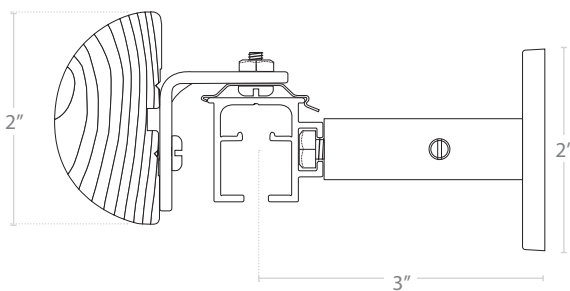

WALL SUPPORT

EURO-SCOPE UPGRADE

i Make Back drape a minimum of 3/4" shorter than front drape.

Offset between Euro-Scope Upgrade & front rod.

KONTUR EVO & ALU	7/16"
NEXGEN	1/2"
NEXGEN WOOD	1/2"
TEKNO 25	1/2"
TEKNO 40	1/4"
TEKNO 40 WOOD	1/2"
INVISIBLE	1/2"

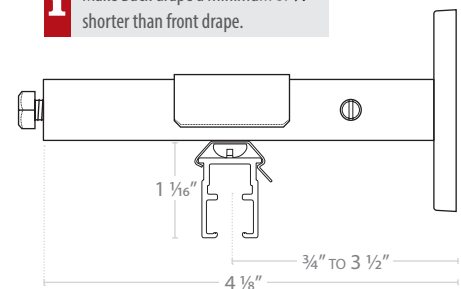

EURO-SCOPE INSTALLATION
4" Support shown